

Hardware User's Manual

Passive avoidance box

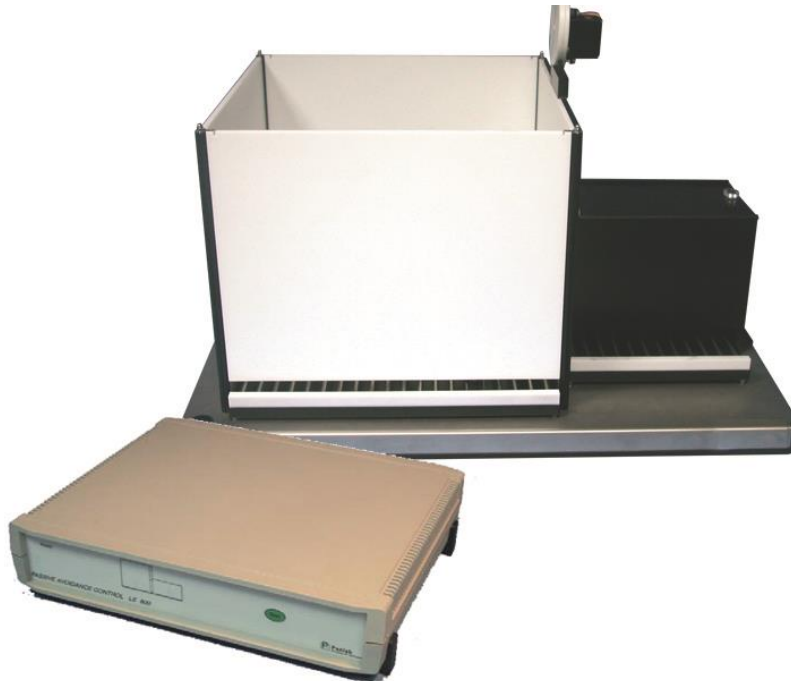

References:

LE870 (76-0199), LE872 (76-0200)

Publication:

PB-MF-MAN-058-REV1.0

Limitation of Liability







PANLAB does not accept responsibility, under any circumstances, for any harm or damage caused directly or indirectly by the incorrect interpretation of what is expressed in the pages of this manual.

Some symbols may have more than one interpretation by professionals unaccustomed to their usage.

PANLAB reserves the right to modify, in part or in total, the contents of this document without notice.

1. SYMBOLS TABLE

Recognising the symbols used in the manual will help to understand their meaning:

DESCRIPTION	SYMBOL
Warning about operations that must not be done because they can damage the equipment	
Warning about operations that must be done, otherwise the user can be exposed to a hazard.	
Protection terminal ground connection.	
Warning about a hot surface which temperature may exceed 65°C	
Warning about a metal surface that can supply electrical shock when it's touched.	
Decontamination of equipments prior to disposal at the end of their operative life	
Waste Electrical and Electronic Equipment Directive (WEEE)	

2. GOOD LABORATORY PRACTICE

Check all units periodically and after periods of storage to ensure they are still fit for purpose. Investigate all failures which may indicate a need for service or repair.

Good laboratory practice recommends that the unit be periodically serviced to ensure the unit is suitable for purpose. You must follow preventive maintenance instructions. In case equipment has to be serviced you can arrange this through your distributor. Prior to Inspection, Servicing, Repair or Return of Laboratory Equipment the unit must be cleaned and decontaminated.



Decontamination prior to equipment disposal

In use this product may have been in contact with bio hazardous materials and might therefore carry infectious material. Before disposal the unit and accessories should all be thoroughly decontaminated according to your local environmental safety laws.

3. UNPACKING AND EQUIPMENT INSTALLATION



WARNING: Failure to follow the instructions in this section may cause equipment faults or injury to the user.

- A. No special equipment is required for lifting but you should consult your local regulations for safe handling and lifting of the equipment.
- B. Inspect the instrument for any signs of damage caused during transit. If any damage is discovered, do not use the instrument and report the problem to your supplier.
- C. Ensure all transport locks are removed before use. The original packing has been especially designed to protect the instrument during transportation. It is therefore recommended to keep the original carton with its foam parts and accessories box for re-use in case of future shipments. Warranty claims are void if improper packing results in damage during transport.
- D. Place the equipment on a flat surface and leave at least 10 cm of free space between the rear panel of the device and the wall. Never place the equipment in zones with vibration or direct sunlight.
- E. Once the equipment is installed in the final place, the main power switch must be easily accessible.
- F. Only use power cords that have been supplied with the equipment. In case that you have to replace them, the spare ones must have the same specs that the original ones.



- G. Make sure that the AC voltage in the electrical network is the same as the voltage selected in the equipment. **Never connect the equipment to a power outlet with voltage outside these limits.**



WARNING

For electrical safety reasons you only can connect equipment to power outlets provided with earth connections .

This equipment can be used in installations with category II over-voltage according to the General Safety Rules.

The manufacturer accepts no responsibility for improper use of the equipment or the consequences of use other than that for which it has been designed.

PC Control

Some of these instruments are designed to be controlled from a PC. To preserve the integrity of the equipment it is essential that the attached PC itself conforms to basic safety and EMC standards and is set up in accordance with the manufacturers' instructions. If in doubt consult the information that came with your PC. In common with all computer operation the following safety precautions are advised.



- WARNING**
- To reduce the chance of eye strain, set up the PC display with the correct viewing position, free from glare and with appropriate brightness and contrast settings
 - To reduce the chance of physical strain, set up the PC display, keyboard and mouse with correct ergonomic positioning, according to your local safety guidelines.

Class A equipment is intended for use in an industrial environment.

This equipment has been tested and found to comply with the limits for a Class A digital device, pursuant to part 15 of the FCC rules. These limits are designed to provide reasonable protection against harmful interference when the equipment is operated in a commercial environment. This equipment generates, uses and can radiate radio frequency energy and if not installed and used in accordance with these instructions, may cause harmful interference to radio communications. Operation of this equipment in a residential area is likely to cause harmful interference in which case the user will be required to correct the interference at his own expense.



- WARNING**

4. MAINTENANCE



WARNING: Failure to follow the instructions in this section may cause equipment fault.

- **PRESS KEYS SOFTLY** – Lightly pressing the keys is sufficient to activate them.
- Equipments do not require being disinfected, but cleaned for removing urine, faeces and odour. To do so, we recommend using a wet cloth or paper with soap (which has no strong odour). **NEVER USE ABRASIVE PRODUCTS OR DISSOLVENTS.**
- **NEVER** pour water or liquids on the equipment.
- Once you have finished using the equipment turn it off with the main switch. Clean and check the equipment so that it is in optimal condition for its next use.
- The user is only authorised to replace fuses with the specified type when necessary.

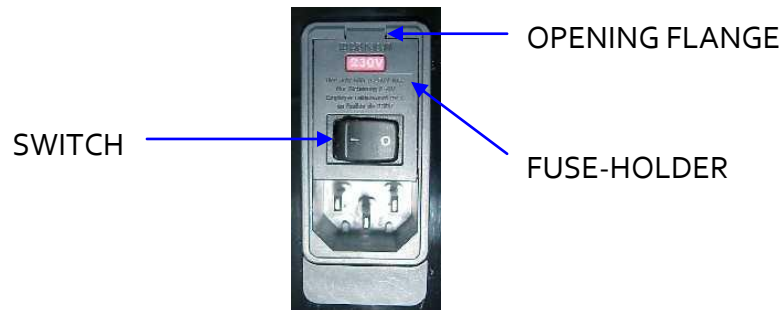

Figure 1. Power inlet, main switch and fuse holder.

FUSE REPLACEMENT

In case of an over-voltage or other incident in the AC net making it impossible to turn on the equipment, check fuses according to the following procedure.

- 1 Remove power cord from the power inlet

- 2 Open fuse-holder by pulling the flange with a regular screwdriver

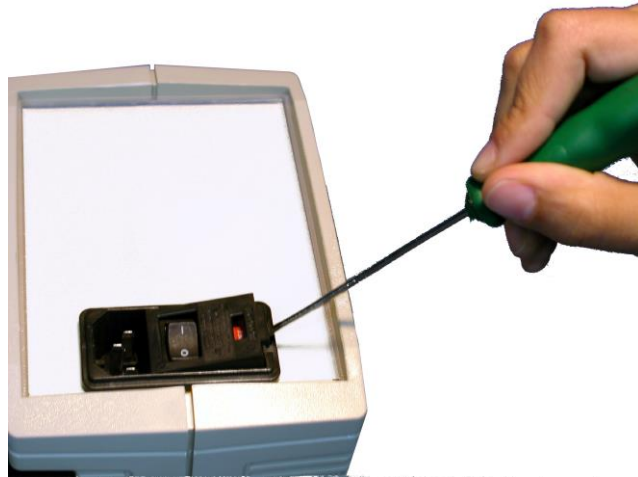

Figure 2. Open fuse-holder door.

- 3 Extract fuse holder using the screwdriver.

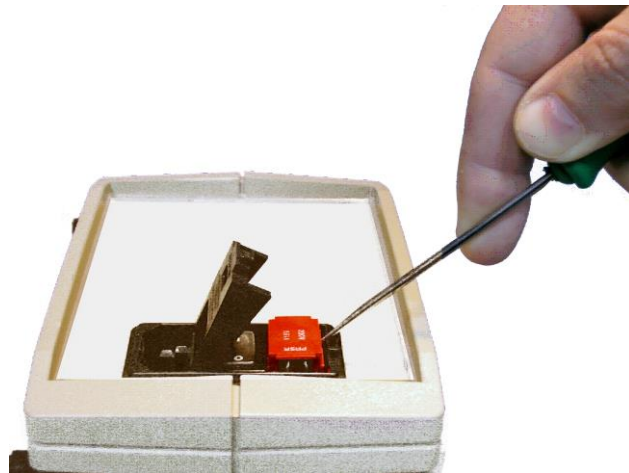

Figure 3. Extract fuse-holder.

- 4 Replace fuses if necessary. Insert fuses in the fuse-holder in the correct position.



CORRECT



INCORRECT

Figure 4. Fuses position.

- 5 Insert again fuse-holder, both possible positions are correct because power supply is universal.
- 6 If the fuses blow again unplug the equipment and contact technical service.



WARNING

For electrical safety, never open the equipment. The power supply has dangerous voltages.

5. TABLE OF CONTENTS

1. SYMBOLS TABLE	2
2. GOOD LABORATORY PRACTICE	2
3. UNPACKING AND EQUIPMENT INSTALLATION	3
4. MAINTENANCE	5
5. TABLE OF CONTENTS	7
6. INTRODUCTION	9
7. EQUIPMENT DESCRIPTION	10
7.1. CONTROL UNIT FRONT PANEL	10
7.2. CONTROL UNIT REAR PANEL	11
7.3. EXPERIMENTATION CAGE	12
8. EQUIPMENT CONNECTION	14
8.1. CONTROL WITH COMPUTER	14
8.2. CONTROL WITH LE 2708	17
9. WORKING WITH THE EQUIPMENT	19
9.1. PROCEDURE	19
9.2. AUTOMATIC ERROR WARNING	19
10. RECOMMENDATIONS	21
10.1. GRIDS CLEANING	21
10.2. TRAYS CLEANING	21
10.3. WALLS CLEANING	21
11. TROUBLESHOOTING	22
12. PREVENTIVE MAINTENANCE	24

13. TECHNICAL SPECIFICATIONS

25

6. INTRODUCTION

The LE 800 Passive Avoidance Control is a system designed to conduct Passive Avoidance experiments. The system is made up of a control unit and an experimentation cage. The experimentation cage has 2 sides: the left side is larger, is white and does not have an electrical grid; the right side is smaller, is black and has an electrical grid to apply shock to the animal. There is a door controlled by a motor between the two compartments.

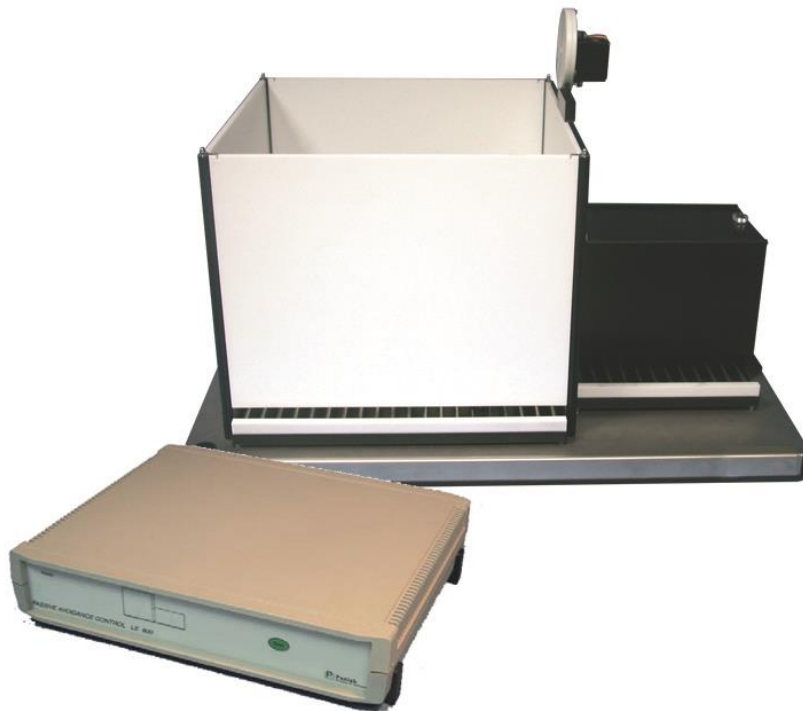

Figure 5. Passive avoidance system.

There are 2 experimental cage models, one for rats and one for mice. The control unit can work with either one by simply changing a selector on the rear panel.

The position of the animal is detected using load cells installed below the platform. Each tray that contains the grid has four legs that transmit weight to the load cell. The system will not change side detection until the animal has moved completely to the other side.

The experiment can be controlled using:

- **Computer:** The computer can control up to 8 cages using **Shutavoid** software and connecting the control units to serial port.
- **Programmer:** The LE 2708 programmer can control 1 cage.

7. EQUIPMENT DESCRIPTION

7.1. CONTROL UNIT FRONT PANEL

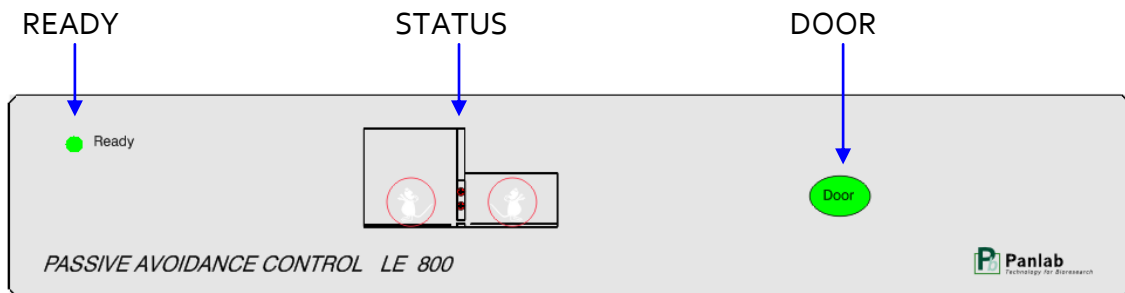

Figure 6. Control unit, front panel.

- **READY:** Green led. When the LE 800 control unit is turned on, it will flash for 20 seconds indicating that system is auto-calibrating. After this period it will remain on continuously indicating that system is ready to work.
- **STATUS:** Schematic diagram of the cage with four leds that show the status of the cage (door open/closed and animal position)

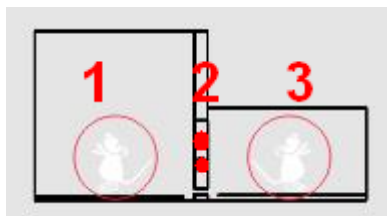

Figure 7. Box status leds.

- Animal position left (1) and right (3). Two white leds.
 - Door closed (2). Two small red leds that remain on when door is closed.
- **DOOR:** This button is used to test the door that separates the white and black sides of the experimentation cage.

7.2. CONTROL UNIT REAR PANEL

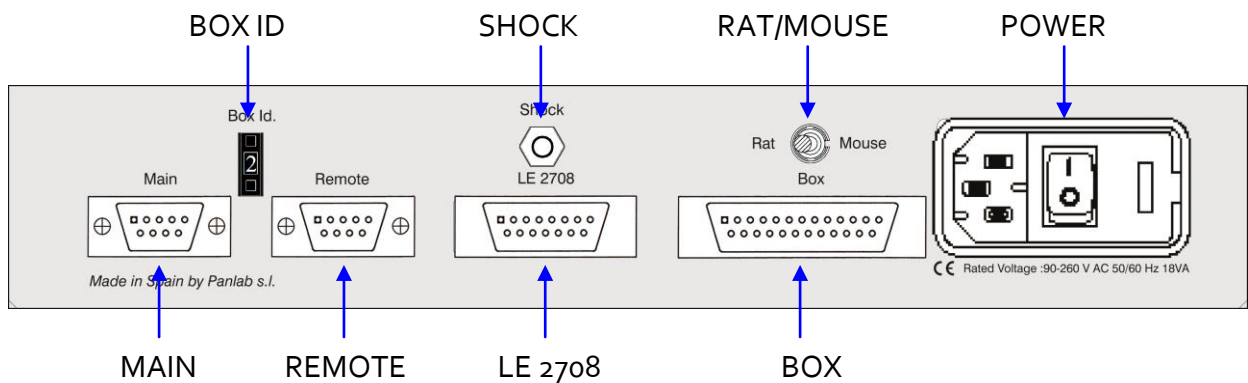

Figure 8. Control unit rear panel.

- **BOX ID:** Decimal selector used when the system is controlled by computer. When several cages are connected to the same computer there can not be 2 cages with the same ID number.
- **MAIN:** DB9 female connector used to connect the LE 800 to the serial port of the computer. When the computer controls several control units connected in cascade, the serial port of the computer is connected to the MAIN port of the first control unit, and the MAIN port of the next unit is connected to the REMOTE port of the previous control unit. The REMOTE port of the last unit is left free.
- **REMOTE:** DB9 male connector used to connect the control unit to the MAIN port of the next control unit when several cages are controlled by a computer. The REMOTE port of the last unit is left free.
- **LE 2708:** DB15 female connector used to connect the control unit to the LE 2708 programmer when control is not performed by computer.
- **BOX:** DB25 female connector used to connect the control unit to the experimentation cage. It transmits load cell signals and door activation signals.
- **SHOCK:** Connects the LE 800 with the LE 100-26 Shocker. It sends the signal to activate the shocker.
- **RAT/MOUSE:** Selector to set the model of cage being used (rat or mouse).
- **POWER:** Power inlet, main switch and fuse holder.

7.3. EXPERIMENTATION CAGE

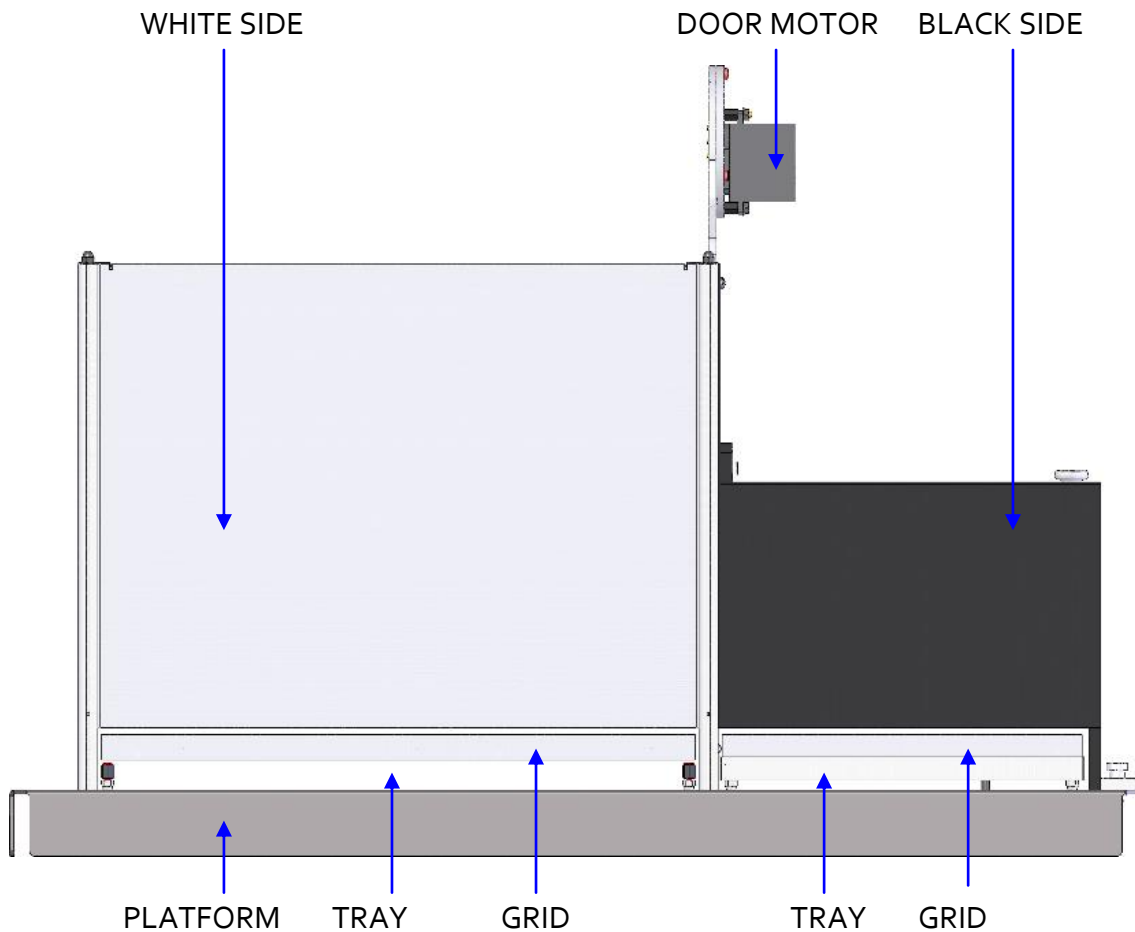

Figure 9. Experimentation cage front view.

- **WHITE SIDE:** The left side is bigger and white. It has a grid in the floor, but shock can not be applied with it.
- **BLACK SIDE:** The right side is smaller and black. It has a grid in the floor which can apply shock to the animal.
- **DOOR MOTOR:** There is a door between the white and black sides that can be opened and closed. It is controlled by a motor.
- **PLATFORM:** The platform is the base of the experimentation cage. There are 2 load cells (one for each side) below the platform.
- **TRAY:** Each side has a tray that holds the grid and collects animal excrements. The trays can be removed to clean the cage. They have 4 legs to transmit weight to the load cell.
- **GRID:** Each side has a grid that is set in the tray. Only the right-side grid (black side of cage) can apply shock to the animal.

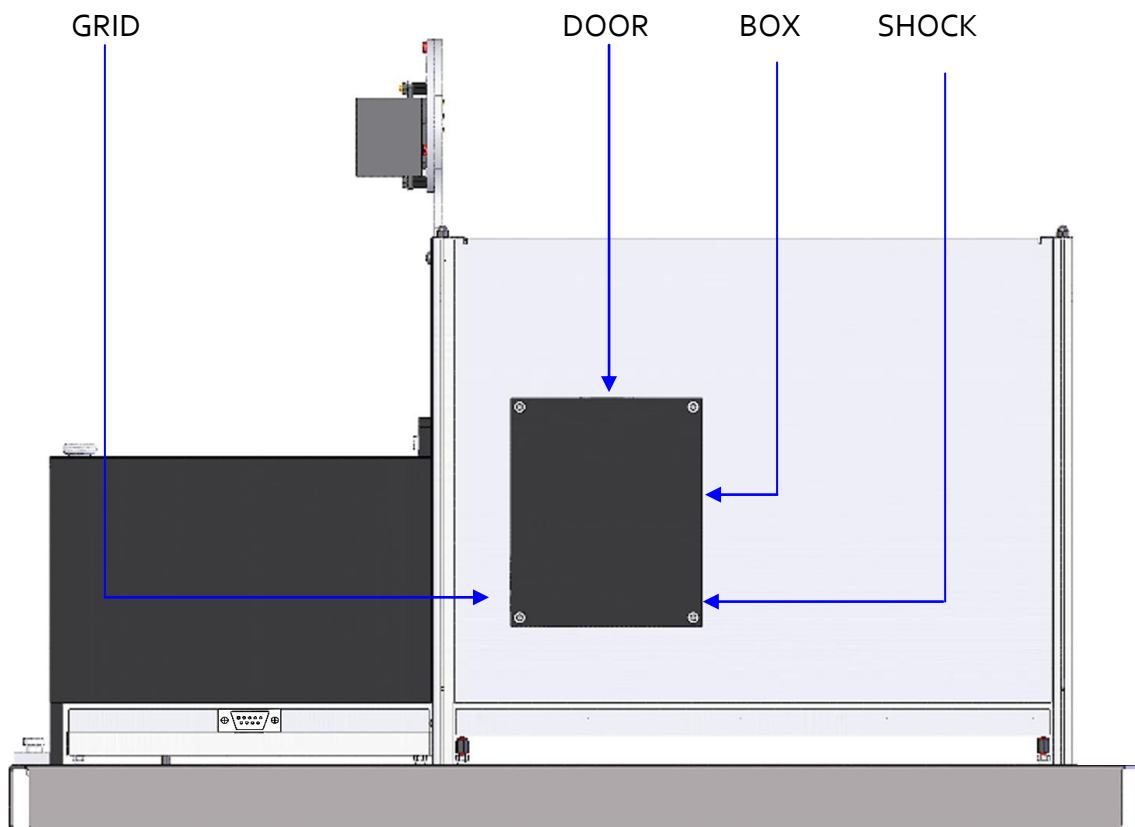

Figure 10. Experimentation cage rear view.

There is a central box containing all the connections on the rear panel of the experimentation cage:

- **GRID CONNECTOR:** DIN 6 female connector that transmits shock to the right-side grid (black side).
- **MOTOR CONECTOR:** DB9 female connector at top side of the central box to control the door.
- **BOX CONNECTOR:** DB25 male connector used to connect the experimentation cage with the box connector on the rear panel of the control unit.
- **SHOCK CONNECTOR:** DIN 6 female connector used to connect experimentation cage to the LE 100-26 Shocker or the LE 2708 Programmer.

8. EQUIPMENT CONNECTION

8.1. CONTROL WITH COMPUTER

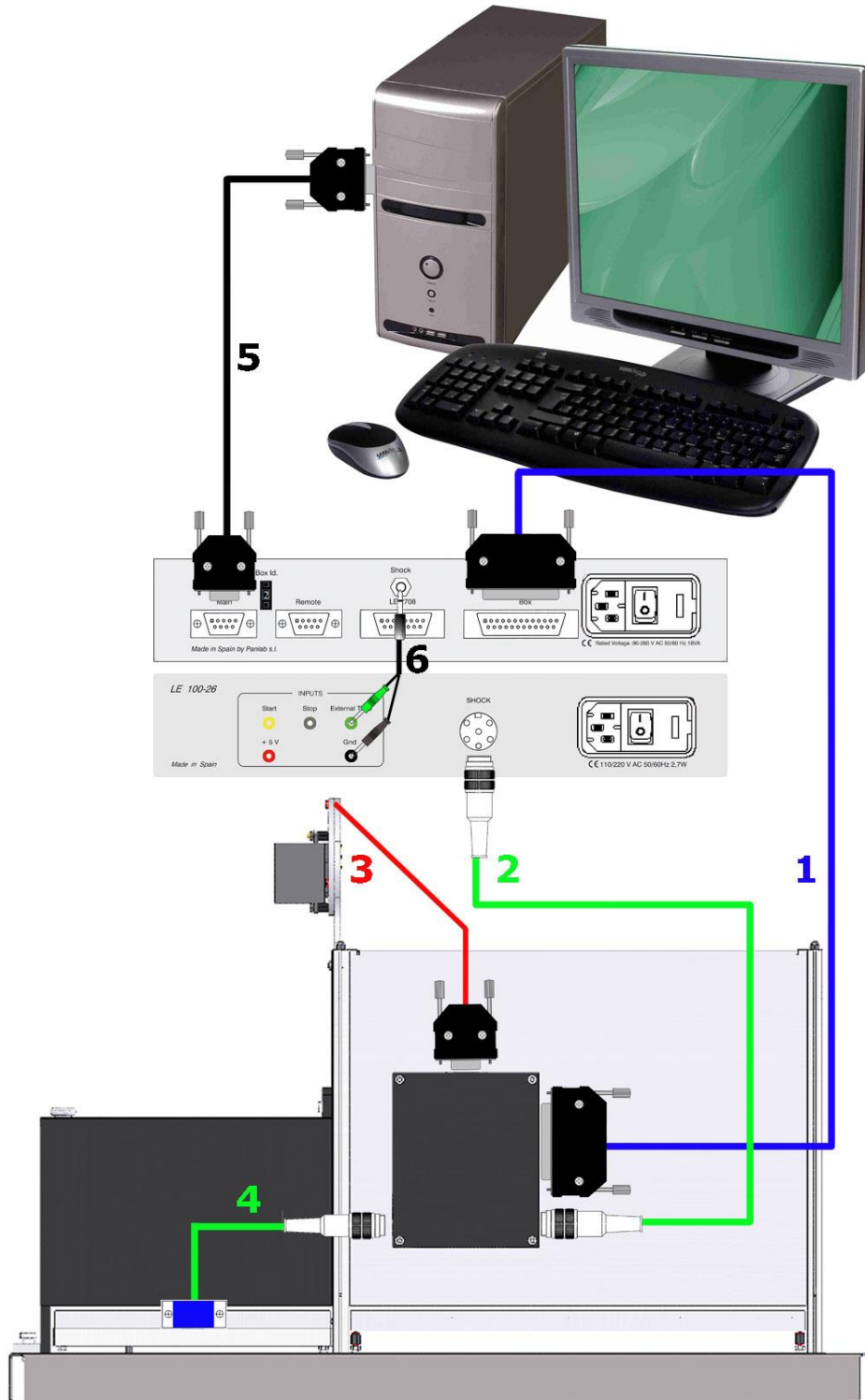

Figure 11. Connections schematic for control with computer.

The necessary connections when controlling passive avoidance with a computer are the following:

	FROM	TO	CABLE
1	LE 800 BOX	CAGE BOX	DB25 cable
2	LE100-26 SHOCK	CAGE SHOCK	DIN6 cable
3	MOTOR	CAGE	DB9 cable
4	GRID black	CAGE	DIN6 to DB9 flat cable
5	LE 800 MAIN	PC SERIAL PORT	RS-232 cable
6	LE 800 Shock	LE 100-26 External Time and GND	3.5mm mono jack to green and black banana cable

A computer can control up to 8 Passive Avoidance cages. When working with several cages, connection between control units and computer is the following (an example of connection of 3 cages is shown in the Figure 12).

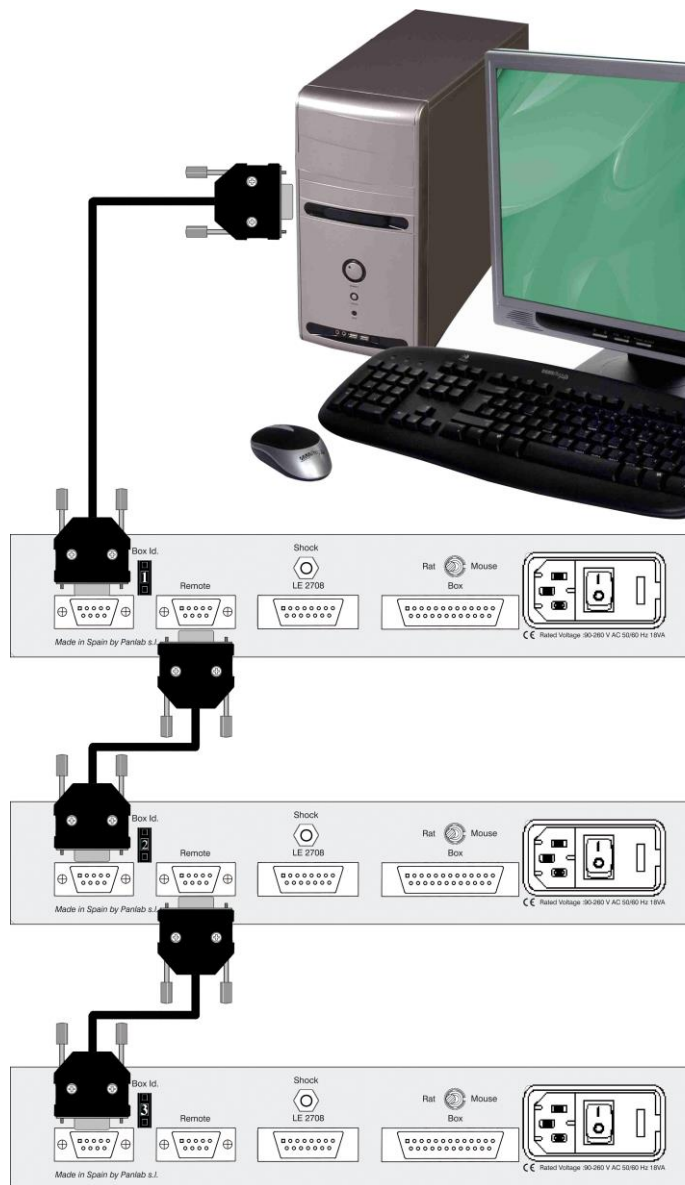

Figure 12. Example: Control of 3 cages with same computer.

Some important points must be followed when working with more than one cage:

- All the units must have different IDs so that the computer can identify them.
- It is not necessary for all ID numbers to be correlative. For example, it is as correct to work with cages 1, 2 and 3 as it is to work with cages 1, 5 and 7.
- It is not necessary for cages to be physically located in the order of their ID numbers. For example it will be correct to work with cages 1-2-3, 1-3-2, 2-1-3, 2-3-1, 3-1-2 or 3-2-1.
- The computer serial port is always connected to the MAIN port of the first control unit.
- The REMOTE port of each control unit is always connected to the MAIN port of the next control unit.
- The REMOTE port of the last control unit is left free.

8.2. CONTROL WITH LE 2708

The LE 2708 Programmer can only control one passive avoidance cage. The necessary connections are shown in the following schematic.

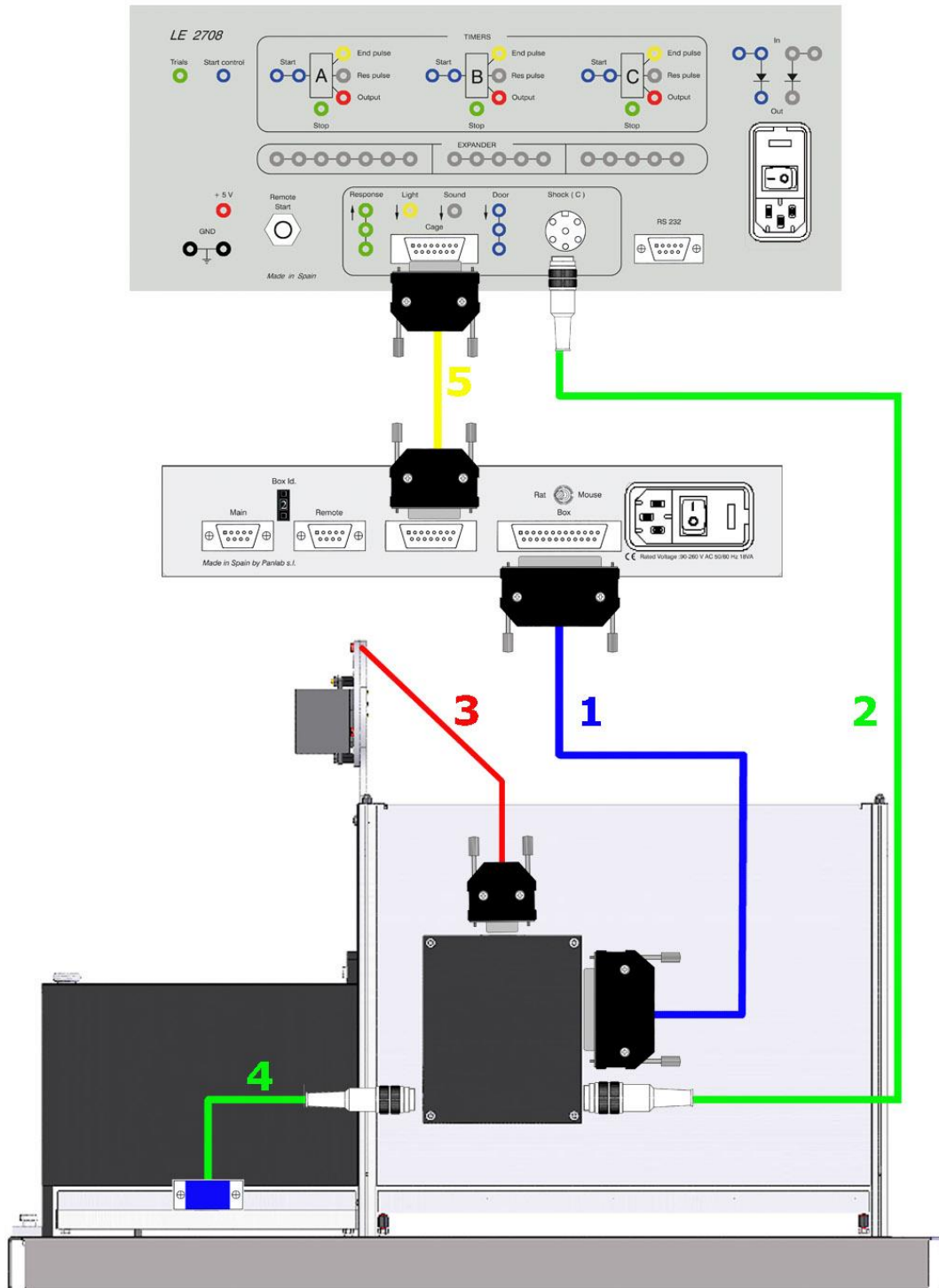

Figure 13. Control with LE 2708.

The connections necessary to program the LE 2708 are not described in this manual. If further information is required, please read the LE 2708 **Quick Procedure**.





The necessary connections are described in the following table:

	FROM	TO	CABLE
1	LE 800 BOX	CAGE BOX	DB25 cable
2	LE 2708 SHOCK	CAGE SHOCK	DIN6 cable
3	MOTOR	CAGE	DB9 cable
4	GRID black	CAGE	DIN6 to DB9 flat cable
5	LE 2708 CAGE	LE 800 (LE 2708)	DB15 cable

9. WORKING WITH THE EQUIPMENT

9.1. PROCEDURE

The following procedure must be followed to work with equipment:

- 1 Connect all the cables (see Chapter 8 of this manual).
- 2 If you work with the program **Shutavoid** and several control units, choose a different ID for each cage 
- 3 Connect the control unit to the AC network and turn it on.
- 4 Wait a few seconds until the  **Ready** led remains continuously on. It will flash during auto-calibration.
- 5 The door can be tested using the button labelled  on the front panel.
- 6 If you're working with the rat cage, select **Rat** with the selector on the rear panel. If you're working with the mice cage, select **Mouse** with the same selector. 
- 7 Place the animal in the cage.
- 8 Follow the **Shutavoid** program or **LE 2708** indications for the experiment with the animal (read related manual depending on the equipment purchased).
- 9 Remove the animal from the cage once the experiment is ended and clean grids and trays.
- 10 Return to point number 7 to begin work with the next animal.
- 11 Once the experiment has finished, turn off all equipment and clean the cage.

9.2. AUTOMATIC ERROR WARNING

The system checks if the cable between the rear panel connector labelled **Box** and the cage is connected.

If the system detects this error, it will warn the user with the 2 flashing white position leds in the **Status box** on the front panel (see Figure 7). The system will be awaiting the solution of the problem (connect the cable). Turn the system on again after solving the problem.

Once the cable is connected, if the system detects that a load cell is damaged it will warn the user by flashing the white position led for this load cell (see Figure 7).

10. RECOMMENDATIONS

1. The experimentation cage must be periodically cleaned.
2. Trays and grids can be removed for cleaning. Turn off the control unit and disconnect the flat cable that joins the cage with the black-side shock grid prior to removing it.
3. Once grids and trays are returned to the cage make sure that they are correctly installed (the four legs of the trays must be in the load cell supports to correctly transmit weight to them).
4. System auto-calibration must be done without animals on the grid (during auto-calibration the system detects the grid and tray weight and balances them to detect animal weight).
5. Although it is not strictly necessary, it is recommended to wait 10 minutes after turning on the equipment before placing any animals on the grid (period necessary for the system to reach a permanent thermal state).

10.1. GRIDS CLEANING

In the Passive Avoidance cage only the black side grid is prepared to supply electrical shock to the animal, however you should clean both grids in order to keep the cage in good conditions to work.

When there is dirt in the grid the electrical shock flows through it. This will produce erroneous data during the experiment because the animal behaviour to the shock negative reinforcement will not be correct (it will not receive punishment).

In order to clean the grids you can use water and soap and then you must dry them. Grids sest can be removed from the trays in order to clean them. Be sure to dry well the DBg connector otherwise contacts may rust with the time.

Special care must be taken in cleaning the plastic between bars, because urine is a good electrical conductor and current flow through it.

10.2. TRAYS CLEANING

Trays contains the grids and collet faeces and urine, they should be cleaned after each experiment, in order to clean them, you should remove them from the cage and then you can use a soapy solution and finally dry them.

10.3. WALLS CLEANING

To clean the walls you can use a lightly wet cloth and then dry them with a dry cloth. If they're too dirty you can wet the cloth with a soapy solution to clean them, then remove foam with a wet cloth and finally dry them with a dry cloth.

11. TROUBLESHOOTING

This table features instructions to solve the most frequent problems.

PROBLEM	SOLUTION
The equipment does not start up.	<ul style="list-style-type: none"> • Check the condition of the fuses.
The two white position leds are blinking.	<ul style="list-style-type: none"> • Ensure that the cable DB25 connects the cage and control unit. • Check that trays and grids are correctly placed. • If the cable is connected and all is correctly placed this means both load cells are damaged.
One of the white position leds is blinking.	<ul style="list-style-type: none"> • The load cell is damaged or blocked.
The door does not open.	<ul style="list-style-type: none"> • Check that door cable is connected. • Check that DB25 cable is connected. • Check that Ready led is on, if it's blinking system still is auto balancing and door will not work.
The control unit does not detect animal position.	<ul style="list-style-type: none"> • Check that Ready led is on. • Check that grids and trays are correctly placed. • Check that the RAT/MOUSE switch is in the correct position. (Rat weight threshold detection is 30gr, if you work with mice the equipment will not be able to detect them).
The animal does not receive shock.	<ul style="list-style-type: none"> • Check that DIN6 cable is connected between the shock generator and cage. • Check that the DB9 to DIN6 cable is connected between the grid and the cage. • Check that jack mono to green and black bananas is connected

	<p>between control unit and LE100-26 Shocker.</p> <ul style="list-style-type: none"> • Check that SHOCK/CALIBRATION switch in the shock generator is in the SHOCK position. • Check that the INTENSITY knob in the shock generator is set to a value higher than omA. • Check that the grid is clean (urine and excrements can conduct current).
<p>The equipment does not communicate with Shutavoid.</p>	<ul style="list-style-type: none"> • Make sure your equipment is connected to PC via RS-232. • Check that Shutavoid settings so that the serial port is correct. • Restart the equipment and the PC to do a RESET in communications. • Check in the rear panel of control unit that the ID number is the same that the one set in Shutavoid.

12. PREVENTIVE MAINTENANCE

	EXPERIMENT	MONTHLY
GRIDS CLEANING	<input checked="" type="checkbox"/>	
TRAYS CLEANING	<input checked="" type="checkbox"/>	
WALLS CLEANING		<input checked="" type="checkbox"/>
CHECK GRID AND TRAY PLACING	<input checked="" type="checkbox"/>	

13. TECHNICAL SPECIFICATIONS

<p>POWER SUPPLY</p> <p>Input voltage: Frequency: Fuse: Maximum Power: Conducted Noise:</p>	<p>Universal input 100 Vac to 240 Vac 50 /60 Hz 2 fuses 5x20mm 2A 250V Fast 18 W EN55022 /CISPR22/CISPR16 class B</p>																				
<p>ENVIRONMENTAL CONDITIONS</p> <p>Operating temperature: Operating relative humidity: Storage temperature:</p>	<p>10°C to +40°C 0% to 85% RH, non-condensing 0°C to +50°C, non-condensing</p>																				
<p>POSITION DETECTION</p> <p>Rat: Mouse:</p>	<p>30 gr 7 gr</p>																				
<p>CONNECTOR MAIN, REMOTE</p> <table border="1"> <thead> <tr> <th><u>Pin</u></th> <th><u>Function</u></th> </tr> </thead> <tbody> <tr> <td>2</td> <td>Rxd</td> </tr> <tr> <td>3</td> <td>Txd</td> </tr> <tr> <td>5</td> <td>Gnd</td> </tr> <tr> <td>7</td> <td>Rts</td> </tr> <tr> <td>9</td> <td>Cts</td> </tr> </tbody> </table>	<u>Pin</u>	<u>Function</u>	2	Rxd	3	Txd	5	Gnd	7	Rts	9	Cts									
<u>Pin</u>	<u>Function</u>																				
2	Rxd																				
3	Txd																				
5	Gnd																				
7	Rts																				
9	Cts																				
<p>COMUNICATIONS OUTPUT</p> <p>Standard Interface: Connector: Transmission speed:</p>	<p>RS232C Delta 9 contacts connector 19200 bauds, 8 bits, no parity</p>																				
<p>CONNECTOR LE2708</p> <table border="1"> <thead> <tr> <th><u>Pin</u></th> <th><u>Function</u></th> </tr> </thead> <tbody> <tr> <td>1</td> <td>Door input</td> </tr> <tr> <td>4</td> <td>Shock Input</td> </tr> <tr> <td>5</td> <td>Right Output</td> </tr> <tr> <td>6</td> <td>Left Output</td> </tr> <tr> <td>7</td> <td>Change Output</td> </tr> <tr> <td>9</td> <td>+ 5V</td> </tr> <tr> <td>15</td> <td>Gnd</td> </tr> </tbody> </table>	<u>Pin</u>	<u>Function</u>	1	Door input	4	Shock Input	5	Right Output	6	Left Output	7	Change Output	9	+ 5V	15	Gnd					
<u>Pin</u>	<u>Function</u>																				
1	Door input																				
4	Shock Input																				
5	Right Output																				
6	Left Output																				
7	Change Output																				
9	+ 5V																				
15	Gnd																				
<p>CONNECTOR BOX</p> <table border="1"> <thead> <tr> <th><u>Pin</u></th> <th><u>Function</u></th> </tr> </thead> <tbody> <tr> <td>1</td> <td>Door +</td> </tr> <tr> <td>2</td> <td>Door GND</td> </tr> <tr> <td>10</td> <td>Transducer left S-</td> </tr> <tr> <td>11</td> <td>Transducer left S+</td> </tr> <tr> <td>12</td> <td>Transducer Right S+</td> </tr> <tr> <td>13</td> <td>Transducer Right S-</td> </tr> <tr> <td>23</td> <td>Transducer +Exc (10V)</td> </tr> <tr> <td>24</td> <td>Transducer - Exc</td> </tr> <tr> <td>25</td> <td>Gnd</td> </tr> </tbody> </table>	<u>Pin</u>	<u>Function</u>	1	Door +	2	Door GND	10	Transducer left S-	11	Transducer left S+	12	Transducer Right S+	13	Transducer Right S-	23	Transducer +Exc (10V)	24	Transducer - Exc	25	Gnd	
<u>Pin</u>	<u>Function</u>																				
1	Door +																				
2	Door GND																				
10	Transducer left S-																				
11	Transducer left S+																				
12	Transducer Right S+																				
13	Transducer Right S-																				
23	Transducer +Exc (10V)																				
24	Transducer - Exc																				
25	Gnd																				

DIMENSIONS (Control Unit) Width x Height x Depth: Weight:	285mm x 70mm x 250mm 1.84 kg
---	---------------------------------

DIMENSIONS (Cage)				
MODEL	Width	Height with door	Depth	Weight
	mm	mm	mm	kg
LE870 (rat)	582	416	402	12.5
LE872 (mouse)	582	416	362	10.5

**DECLARACIÓN DE CONFORMIDAD
DECLARATION OF CONFORMITY
DECLARATION DE CONFORMITÉ**

Nombre del fabricante: **Panlab s.l.u.**
 Manufacturer's name: www.panlab.com
 Nom du fabricant: info@panlab.com

Dirección del fabricante: **Energía, 112**
 Manufacturer's address: **08940 Cornellà de Llobregat**
 Adresse du fabricant: **Barcelona SPAIN**

Declaro bajo su responsabilidad que el producto: **Passive Avoidance**
 Declares under his responsibility that the product:
 Déclare sous sa responsabilité que le produit:

Marca / Brand / Marque: **PANLAB**

Modelo / Model / Modèle: **LE 870 - LE 872**

Cumple los requisitos esenciales establecidos por la Unión Europea en las directivas siguientes:
 Fulfils the essential requirements established by The European Union in the following directives:
 Remplit les exigences essentielles établies pour l'Union Européenne selon les directives suivantes:

- 2006/95/EC** Directiva de baja tensión / Low Voltage / Basse tension
- 2004/108/EC** Directiva EMC / EMC Directive / Directive CEM
- 2012/19/EU** La Directiva de Residuos de Aparatos Eléctricos y Electrónicos (WEEE) / The Waste Electrical and Electronic Equipment Directive (WEEE) / Les déchets d'équipements électriques et électroniques (WEEE)
- 2011/65/EU** Restricción de ciertas Sustancias Peligrosas en aparatos eléctricos y electrónicos (ROHS) / Restriction of the use of certain Hazardous Substances in electrical and electronic equipment (ROHS) / Restriction de l'utilisation de certaines substances dangereuses dans les équipements électriques et électroniques (ROHS)
- 2006/42/EC** Directiva mecánica / Machinery directive / Directive mécanique

Para su evaluación se han aplicado las normas armonizadas siguientes:
 For its evaluation, the following harmonized standards were applied:
 Pour son évaluation, nous avons appliqué les normes harmonisées suivantes:

- Seguridad / Safety / Sécurité: **EN61010-1:2011**
- EMC: **EN61326-1:2013 Class A¹**
- Safety of machinery: **EN ISO 12100:2010**

¹This equipment complies with the limits for class A equipment in accordance with CISPR 11 definition and is classed as a Class A digital device, pursuant to CFR Title 47 part 15 of the FCC Rules and is intended to be used in an industrial environment.

En consecuencia, este producto puede incorporar el marcado CE:
 Consequently, this product can incorporate the CE marking:
 En conséquence, ce produit peut incorporer le marquage CE:



En representación del fabricante:
 Manufacturer's representative:
 En représentation du fabricant: **Carme Canalís**
General Manager
Panlab s.l.u., a division of Harvard BioScience

Cornellà de Llobregat, Spain
 30/04/2014

(GB) Note on environmental protection:



After the implementation of the European Directive 2002/96/EU in the national legal system, the following applies:

Electrical and electronic devices may not be disposed of with domestic waste. Consumers are obliged by law to return electrical and electronic devices at the end of their service lives to the public collecting points set up for this purpose or point of sale. Details to this are defined by the national law of the respective country. This symbol on the product, the instruction manual or the package indicates that a product is subject to these regulations. By recycling, reusing the materials or other forms of utilising old devices, you are making an important contribution to protecting our environment.

(E) Nota sobre la protección medioambiental:



Después de la puesta en marcha de la directiva Europea 2002/96/EU en el sistema legislativo nacional, Se aplicara lo siguiente:

Los aparatos eléctricos y electrónicos, así como pilas y baterías, no se deben tirar a la basura doméstica. El usuario está legalmente obligado a llevar los aparatos eléctricos y electrónicos, así como pilas y baterías, al final de su vida útil a los puntos de recogida municipales o devolverlos al lugar donde los adquirió. Los detalles quedaran definidos por la ley de cada país. El símbolo en el producto, en las instrucciones de uso o en el embalaje hace referencia a ello. Gracias al reciclaje, a la reutilización de materiales i a otras formas de reciclaje de aparatos usados, usted contribuirá de forma importante a la protección de nuestro medio ambiente.

(F) Remarques concernant la protection de l'environnement :



Conformément à la directive européenne 2002/96/CE, et afin d'atteindre un certain nombre d'objectifs en matière de protection de l'environnement, les règles suivantes doivent être appliquées.

Elles concernent les déchets d'équipement électriques et électroniques. Le pictogramme "picto" présent sur le produit, son manuel d'utilisation ou son emballage indique que le produit est soumis à cette réglementation. Le consommateur doit retourner le produit usager aux points de collecte prévus à cet effet. Il peut aussi le remettre à un revendeur. En permettant enfin le recyclage des produits, le consommateur contribuera à la protection de notre environnement. C'est un acte écologique.

(D) Hinweis zum Umweltschutz:



Ab dem Zeitpunkt der Umsetzung der europäischen Richtlinie 2002/96/EU in nationales Recht gilt folgendes:

Elektrische und elektronische Geräte dürfen nicht mit dem Hausmüll entsorgt werden. Der Verbraucher ist gesetzlich verpflichtet, elektrische und elektronische Geräte am Ende ihrer Lebensdauer an den dafür eingerichteten, öffentlichen Sammelstellen oder an die Verkaufsstelle zurückzugeben. Einzelheiten dazu regelt das jeweilige Landesrecht. Das Symbol auf dem Produkt, der Gebrauchsanleitung oder der Verpackung weist auf diese Bestimmungen hin. Mit der Wiederverwertung, der stofflichen Verwertung oder anderer Formen der Verwertung von Altgeräten leisten Sie einen wichtigen Beitrag zum Schutz unserer Umwelt.

(I) Informazioni per protezione ambientale:



Dopo l'implementazione della Direttiva Europea 2002/96/EU nel sistema legale nazionale, ci sono le seguenti applicazioni:

I dispositivi elettrici ed elettronici non devono essere considerati rifiuti domestici. I consumatori sono obbligati dalla legge a restituire i dispositivi elettrici ed elettronici alla fine della loro vita utile ai punti di raccolta collerici preposti per questo scopo o nei punti vendita. Dettagli di quanto riportato sono definiti dalle leggi nazionali di ogni stato. Questo simbolo sul prodotto, sul manuale d'istruzioni o sull'imballo indicano che questo prodotto è soggetto a queste regole. Dal riciclo, e re-utilizzo del material o altre forme di utilizzo di dispositivi obsoleti, voi renderete un importante contributo alla protezione dell'ambiente.

(P) Nota em Protecção Ambiental:



Após a implementação da directiva comunitária 2002/96/EU no sistema legal nacional, o seguinte aplica-se:

Todos os aparelhos eléctricos e electrónicos não podem ser despejados juntamente com o lixo doméstico. Consumidores estão obrigados por lei a colocar os aparelhos eléctricos e electrónicos sem uso em locais públicos específicos para este efeito ou no ponto de venda. Os detalhes para este processo são definidos por lei pelos respectivos países. Este símbolo no produto, o manual de instruções ou a embalagem indicam que o produto está sujeito a estes regulamentos. Reciclando, reutilizando os materiais dos seus velhos aparelhos, esta a fazer uma enorme contribuição para a protecção do ambiente.